

Intuition | Innovation | Perfection



MOUNTS • OPTICS • ELECTRONICS

MAKcam V4 Owner's Manual



HDMI



www.mak.ag



Made in Germany

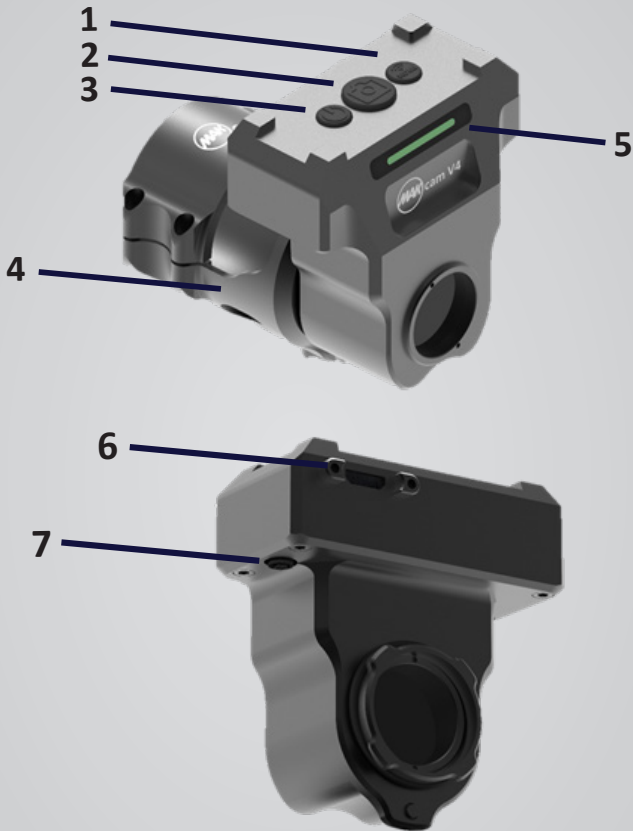

Table of contents

Control Elements	3
Warnings	4
Getting Started	7
Mounting the MAKcam V4 on your riflescope	7
Charging the Battery	9
Powering Camera On and Off	9
Battery Status	9
Modes	10
Default Camera Settings	10
Features	11
Accessing the MAKcam V4	11
Application Interface	13
Maintenance and Service	16
Warranty and Disclaimers	16



Control Elements



1	Wi-Fi/HDMI Button	5	Status LED Bar
2	Shutter Button	6	Mini HDMI Port
3	Power Button	7	Battery Charging Port
4	Scope Mounts		



Warnings

The machine is designed and intended for private use. It should only be used on proper rifle scope. Use for any other purpose will be deemed improper. MAK AG cannot accept any responsibility for the consequences of improper use.

Before using the tool read these instructions for use thoroughly and completely and comply with the instructions they contain. Keep these instructions for use close to the tool and pass them on to the next user.

Conformities

MAKcam V4 is conformed to following directives:

- Low Voltage Directives 2014 /35 /EU
- EMV 2014 / 30 / EU
- RoHS
- REACH



Device is equipped with integrated battery. Do not attempt to replace the battery yourself. The battery in MAKcam V4 should be replaced by KILIC Feintechnik or an authorized service provider.



Using a charger other than a MAKcam V4 can damage the camera battery and could result in fire or leakage. Only use chargers marked: Output 5V 1A.



Battery Warnings

To avoid danger of potentially fatal electric shock:

- Do not dismantle, open or shred integrated battery.
- Do not short-circuit the integrated battery.
- Do not remove integrated battery.
- Do not subject batteries to mechanical shock.
- In the event of a battery leaking, do not allow the liquid to come in contact with the skin or eyes. If contact has been made, wash the affected area with copious amounts of water and seek medical advice.
- Do not use any charger other than that specifically provided for use with the equipment.
- Seek medical advice immediately if a battery has been swallowed.
- Wipe the battery charging port with a clean dry cloth if they become dirty.
- Do not leave a battery on prolonged charge when not in use.



**Observe proper precautions when handling batteries.
Batteries may leak or explode if improperly handled**



**A defective machine is not safe and could cause injury or fire.
To avoid damage and any associated risk of injury or fire:**

- Protect the MAKcam V4 from environmental influences such as rain, frost and direct sunlight.
- Do not immerse the MAKcam V4 cables or connections in water.
- Do not put the MAKcam V4 or any individual parts in the dishwasher.
- Switch your MAKcam V4 off at the power switch before any cleaning operation
- Always wipe the MAKcam V4 with a damp cloth rather than a wet one, and protect it from prolonged exposure to water splash.
- Do not drop, disassemble, open, crush, bend, deform, puncture, shred, microwave, incinerate or paint the camera.
- Do not insert foreign objects into any opening on the camera, such as the USB port.
- Do not dry the camera or battery with an external heat source such as a microwave oven or hair dryer.
- Place the tool out of the reach of children.



Do not place naked flame sources, such as lighted candles, on or near the product.



Getting Started

Mounting the MAKcam V4 on your riflescope

1. First install the camera to scope mount on the ocular side of the scope as in the picture



Picture 1



Picture 2

2. Position the MAKcam V4 on the camera to scope mount so that the male lugs of the camera housing unit mate with the female lug recess in the mount and rotate clockwise until the locking lever engages and locks up.



Please verify that the camera and reticle are aligned. This can be verified by using the HDMI Mode. If not, adjust the mount on the ocular until they are and then tighten the screws on the mount. For the perfect image, it is vital that the alignment of camera and reticle is properly aligned.



3. If you want to dismount the MAKcam V4 unit from the scope you simply operate the locking lever and rotate counter clockwise. The camera to scope mount remains with the rifle scope permanently and is ready to have the camera unit attached without hindering it's normal rifle scope functions.

To verify if the view is perfectly aligned and perpendicular;

- Turn on the HDMI Mode or wifi mode
- Link the MAKcam V4 to the monitor via HDMI cable (see img.2) or connect wifi and start video stream on user interface
- Check if the device is properly aligned



Always check and be certain that the firearm is unloaded before undertaking any work upon it.



Please pay attention that when mounting/installing the camera unit on the rifle scope that the picture quality is clear and clean. When this is not the case you will have to adjust the camera to scope mount slightly forward or aft until clear and clean images are seen. This is best done when the camera unit is connected to the computer.



Charging the Battery

- Charge the battery by connecting the MAKcam V4 using the included charging kit.
- The MAKcam V4 power status led blinks during charging.
- Once the device is completely charged, power led status stops blinking.

Powering Camera On and Off

To Power On:

Press the Power button until the green LED turns on. When the yellow led blinks, MAKcam V4 is ready to use.

To Power Off:





Press the Power button until the green LED turns off

Battery Status

- Power led blinks on the status led bar if the battery drops below 30%.
- If the battery reaches 0% while recording, the camera saves the file and powers off.



Modes

Mode		Start	Stop
	Photo Mode	Press the shutter button. Red led blinks once.	-
	Video Mode	Press and hold the shutter button for two seconds. Red led blink continuously.	Press the shutter button. Red led stops blinking.
	Wi-Fi Stream Mode	Press and hold the Wi-Fi/HDMI button for two seconds. Blue led blinks continuously	Press the Wi-Fi/HDMI button. Blue led stops blinking.
	HDMI Mode	Press the Wi-Fi/HDMI button. Blue led turns on.	Press the Wi-Fi/HDMI button. Blue led turns off.

Default Camera Settings

Default settings for the MAKcam V4 is as following:

- Video/Photo resolution: 720p, 25fps
- HDMI mode resolution: 1080p, 40fps
- Wi-Fi Credentials:

SSID: **MAKcamV4**

Password: **makcam2021**

To reset the Wi-Fi settings;

Wi-Fi button must be pressed for 10+ seconds.

This will reset the wifi ssid and password to the default settings.



MOUNTS • OPTICS • ELECTRONICS

Features

The device is compatible with the MAKcam V4 App, which is available on Windows, Apple and Android devices.

The MAKcam V4 App allows you to control the action camera, retrieve media and provides a live stream through Wi-Fi.

Accessing the MAKcam V4

Smartphones

In order to download the App for the smartphone scan the appropriate QR Code below



www.mak.ag/products/electronics/makcam/makcam-v4/

Desktop

Desktop app for the MAKcam V4 can be downloaded through the

www.mak.ag/products/electronics/makcam/makcam-v4/



Web Browser

Alternatively, any type of web browser can be used to access the camera.

1. Push on the Wi-Fi button for three seconds to activate the wireless mode.
2. Please make sure that the blue blink appears on the status led bar indicating that the Wi-Fi mode is active.
3. In your computer, smart phone or tablet's Wi-Fi settings, connect to the corresponding network that matches the camera's screen. The network name is "**MAKcamV4**" by default.
4. When prompted, enter the password "**makcam2021**" which should also match your camera's screen.
5. Open the **MAKCam V4 app** on your corresponding device. Once open, press connect where it shows the camera icon. Once connected you can change modes and settings from your device as well as preview live stream, media, and download your photos and videos.

Optionally, open your computer's preferred web browser and type in the following address: 192.168.5.1



Application Interface

General overview regarding the application interface is shown below.

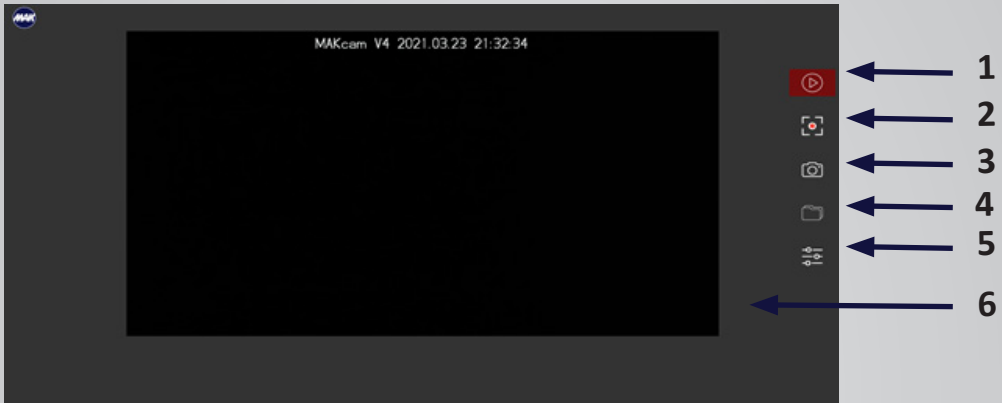

MAKcam V4 Desktop Application

1	Start / Pause Stream: It is used to pause the active stream or start the live preview.
2	Record Video: Pressing on this button is used to start the video record and converts the button background to the red colour indicating that the device is recording video
3	Take a Photo: This button is used to capture a photo.
4	Media Folder: Access to the media folder.
5	Settings: Access to the settings panel.
6	Live Stream: In order to make the live preview full screen, please press on the stream.



Application Interface

General overview regarding the application interface is shown below.



MAKcam V4 Desktop App – Media



MOUNTS • OPTICS • ELECTRONICS

Application Interface

Video/Stream Resolution:

Image Resolution:

Wi-Fi Stream Quality: 6

HDMI Mode - Stream Resolution:

Full-HD 16-9 25fps

HD Ready 16-9 40fps

HD Ready 4:3 40fps

Date

Time

SSID

Password

Language

MAKcam V4 - Settings Panel

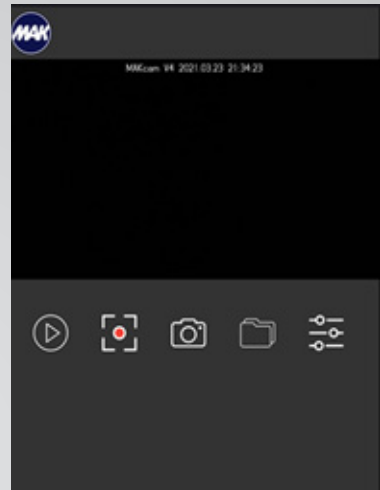

MAKcam V4 for Smartphone



Maintenance and Service

- Only qualified and authorized personnel should make repairs to this product.
- MAKcam V4 is easy to maintain and does not require special maintenance during normal operation.
- Make sure to clean camera regularly with an optical towel.
- Please do not make any change on MAKcam V4 by yourself.

Warranty and Disclaimers

The guarantee period is 5 years on mechanical and 2 years on optical or electronic components. If device becomes defect within this period, please inform our service department. Damage due to incorrect use and interventions are excluded from the guarantee.



MOUNTS • OPTICS • ELECTRONICS

CONTACT OUR CUSTOMER SERVICE DEPARTMENT:



Tel.: +49 9723 93805-0

Fax: +49 9723 93805-129

CONTACT OUR CUSTOMER SERVICE DEPARTMENT VIA
THE INTERNET:



kilic@mak.ag

<https://www.mak.ag>

Customer Satisfaction Survey

Your opinion matters for us.

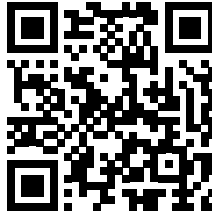

<https://www.surveymonkey.com/r/WN8KDCC>

Environmental notice The symbol



represents the need of separate disposal of the product and accessories. They should not be dumped with regular household waste but must be returned to a recycling collection point for electrical devices. Recycling helps reduce the consumption of raw materials.

All parts labelled with symbol  are valuable for recovery. For more information regarding this matter, contact our company or nearest recycling center. Please also dispose packaging with regarding to your area's environmental regulations



MOUNTS • OPTICS • ELECTRONICS



Warranty Form

If you experience any problems with our products return it with this document enclose an explanation of the problem

Item Number: _____

Product name: _____

Purchased Date: _____

Dealer/Distributor: _____

Your Name: _____

Your Address: _____

City: _____

Phone: _____

E-mail: _____

Brief Remark/Description of problem: _____
